

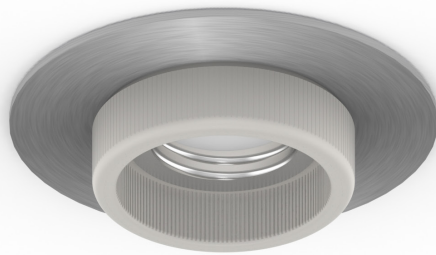

Design: Álvaro Siza
Luminária de encastrar.
Suporte em porcelana.
Lâmpada não incluída.

11010



Suporte: E27	Fonte de luz	IP20 230Vac 50/60Hz
Potência	1x60W	 
Fluxo	n/a	

Dimensões

 mm

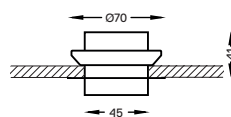



 050

Aplicação



Acabamentos

-  .01 Branco / RAL 9010
-  .12 Aço inox escovado
-  .14 Latão polido

Design: Álvaro Siza

Luminária saliente.

Estrutura em aço pintado,
aço inox escovado ou latão.

Suporte em porcelana.

Lâmpada não incluída.



Suporte: E27

Fonte de luz

IP20 | 230Vac | 50/60Hz

Potência máxima

1x60W



Fluxo

n/a

Dimensões

mm

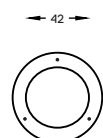
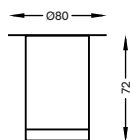

Aplicação



Acabamentos

- .01 Branco / RAL 9010
- .12 Aço inox escovado
- .14 Latão polido

Design: Álvaro Siza
Luminária de pé.
Estrutura e base em aço inox.
Topo em cobre ou aço inox polido.
Cabo em tecido cinzento.
Equipada com regulador de fluxo.



 **LED** 2700K

Fonte de luz

IP20 | 230Vac | 50/60Hz



Potência

18W

Fluxo

1400lm

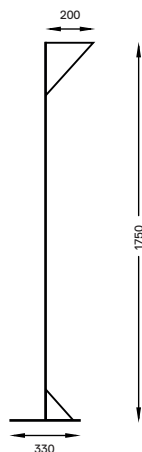

Dimensões



Aplicação



Acabamentos

-  .11 Aço inox polido
-  .15 Cobre

Design: Eduardo Souto de Moura
 Luminária de pé.
 Estrutura em aço pintado.
 Base em betão branco.
 Refletor em alumínio puro
 de elevada reflexão.
 Cabo em tecido cinzento.
 Equipada com regulador de fluxo.
 Lâmpada incluída.

13610

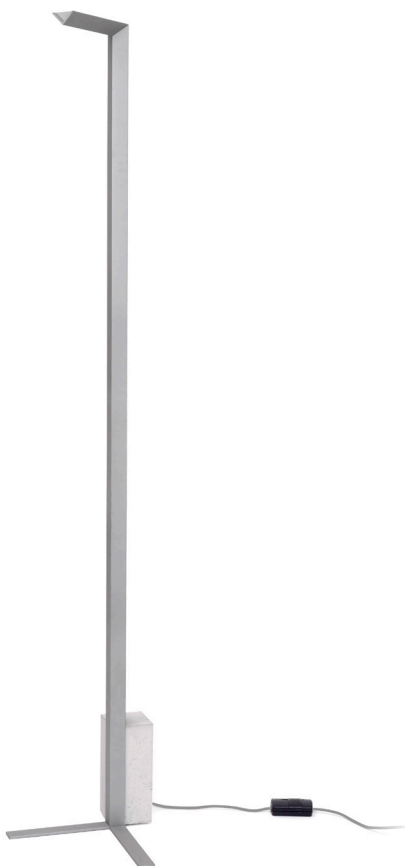

QT-DE

Suporte: R7s

Fonte de luz

IP20 | 230Vac | 50/60Hz



Potência máxima

1x160W

Fluxo

n/a

Dimensões

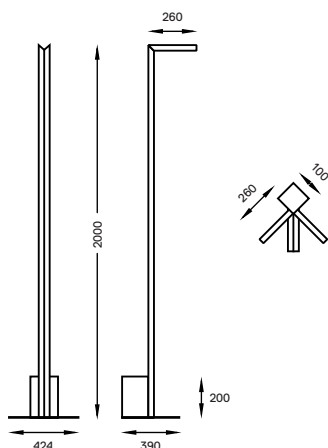

Aplicação



Acabamentos

- .01 Branco / RAL 9010
- .03 Cinzento / RAL 9007

Design: Eduardo Souto de Moura
 Luminária de pé.
 Estrutura em aço pintado.
 Base em betão branco.
 Refletor em alumínio puro de elevada reflexão.
 Cabo em tecido vermelho.
 Equipada com regulador de fluxo.
 Lâmpada incluída.

13600

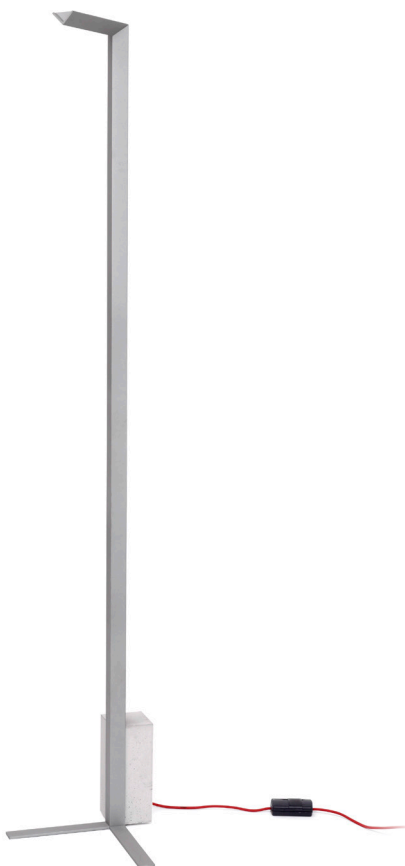

QT-DE

Suporte: R7s

Fonte de luz

IP20 | 230Vac | 50/60Hz



Potência máxima

1x230W

Fluxo

n/a

Dimensões

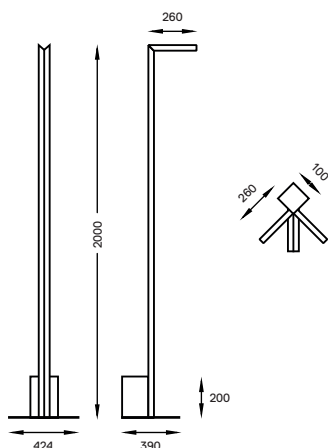

Aplicação



Acabamentos

- .01 Branco / RAL 9010
- .03 Cinzento / RAL 9007

Design: O/M
Luminária saliente.
Suporte em aço inox escovado.
Lâmpada incluída.

12436



Linestra LED

2700K

Fonte de luz

IP20 | 230Vac | 50/60Hz



Potência

1x6W

Fluxo

250lm

Dimensões

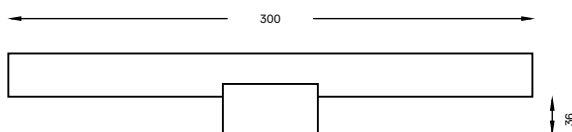

Aplicação



Acabamentos

● .12 Aço inox escovado

Design: O/M
Luminária saliente.
Suporte em aço inox escovado.
Lâmpada incluída.

12446



		
Linestra LED	2700K	Fonte de luz
Potência	1x9W	
Fluxo	450lm	

IP20 | 230Vac | 50/60Hz



Dimensões

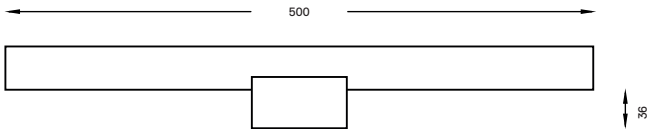

Aplicação



Acabamentos

● .12 Aço inox escovado

Design: O/M
Luminária saliente.
Suporte em aço inox escovado.
Lâmpada incluída.

12456



Linestra LED 2700K

Fonte de luz

IP20 | 230Vac | 50/60Hz

Potência **1x16W**



Fluxo **1000lm**

Dimensões



Aplicação



Acabamentos

● .12 Aço inox escovado

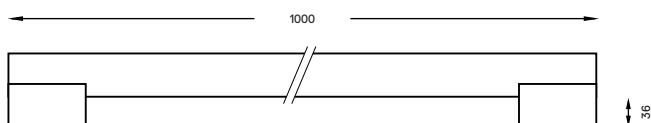

Design: Álvaro Siza
 Luminária de pé.
 Estrutura em aço inox escovado.
 Base e corpo em aço inox polido.
 Refletor em alumínio puro
 de elevada reflexão.
 Cabo em tecido preto.
 Equipada com regulador de fluxo.

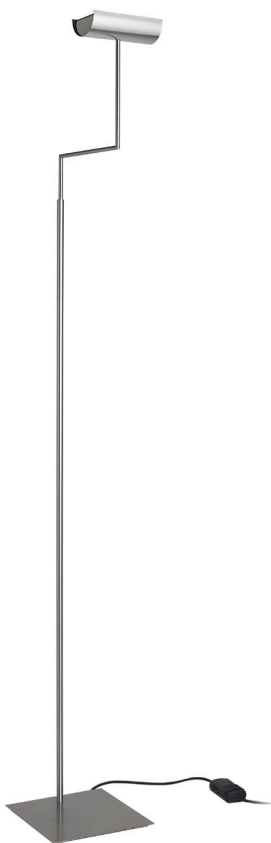

 **LED** 2700K

Fonte de luz

IP20 | 110/230Vac | 50/60Hz



Potência

18W

Fluxo

1400lm

Dimensões

 mm

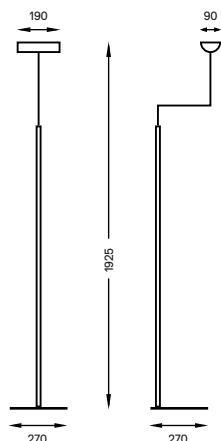

Aplicação



Acabamentos

● .12 Aço inox escovado

Design: Álvaro Siza
Luminária de pé.
Estrutura em aço inox escovado.
Base e corpo em aço inox polido.
Refletor em alumínio puro
de elevada reflexão.
Cabo em tecido cinzento.
Equipada com regulador de fluxo.

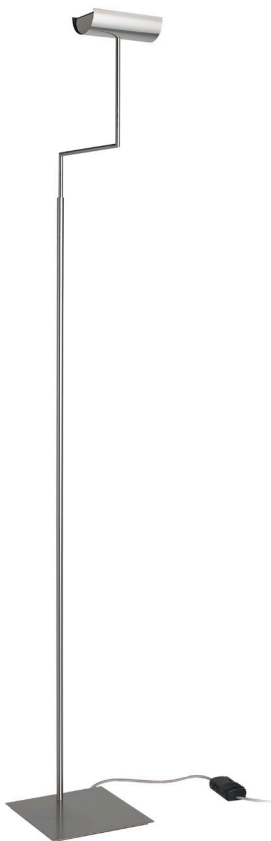

 **LED** 2700K

Fonte de luz

IP20 | 110/230Vac | 50/60Hz



Potência

18W

Fluxo

1400lm

Dimensões

 mm

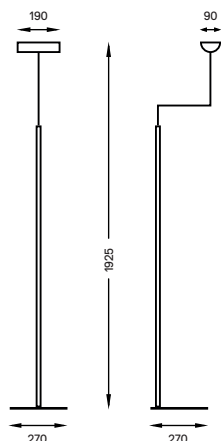

Aplicação



Acabamentos

● .12 Aço inox escovado